



**ALP Marketing
Applications**

Operating Instructions for AD724 Evaluation Board

Input Connections

The AD724EB can be powered by a 5V dc wall type power supply that connects to P3. The center pin of the P3 connector is positive. Optionally it can be powered by +5V and ground via P6.

The Male end of the VGA extender cable is plugged into the source of RGB video. The Female end connects to P2 on the AD724EB. A VGA monitor can be plugged into P1 if desired for convenient switching between monitors.

SW1 (Bypass / Encode) can be used to select between the AD724 encode path or the VGA bypass path. For the VGA Bypass mode to operate properly, the power to the board must be applied due to CMOS loading of the VSYNC signal.

An RGB Multisync monitor should be able to display a good picture when it receives interlaced RGB signals. Other RGB monitors will have trouble displaying interlaced video.

Subcarrier Options

The subcarrier can be provided by any one of several methods. Almost all conceivable options are acceptable.

A 1FSC (NTSC = 3.579545 MHz or PAL = 4.433619 MHz) crystal can be used in position Y3. On-chip circuitry runs the oscillator. For most crystals, a parallel capacitor of from 10-20 pF is required at position C10 for proper frequency and reliable start-up of the oscillator circuit. When the crystal option is used, J3 should be removed and J2 should be installed to select 1FSC operation.

A packaged oscillator of either 1FSC or 4FSC (NTSC = 14.31818 MHz, PAL = 17.734480 MHz) can also be used (either full size or half size). Position Y2 is for an NTSC oscillator and position Y1 is for a PAL oscillator. SW2 selects between the two standards, while at the same time selecting the proper logic level for STND (Pin 1 of AD724).

When either of these oscillator options is used, J3 must be installed and J2 should be configured as appropriate for 1FSC (jumper installed) or 4FSC (no jumper installed) operation. The crystal at position Y3 is not necessary when running from an oscillator. Leaving it in while forcing the subcarrier drive with a packaged oscillator does not appear to affect performance.

A clock of the proper frequency from another source can also be used. It should be CMOS logic levels and approx. 50% duty cycle. It can be connected to the board at position C10.

Power Down

J1 is used to program the power down status. For normal operation, no jumper should be installed. The power down conditions of the IC can be examined by installing J1.

Output Connections

There are two options for video out. Only one is necessary at a time, but both can be used simultaneously. Composite video is output on the RCA (phono) connector. It is ac coupled via a 220 μ F capacitor and back terminated with 75 Ω . This can be connected to the video input of a TV monitor which should provide a 75 Ω termination.

S-video (Y/C Video) is available on the 4-pin circular DIN connector. Each of these is also ac coupled and back terminated with 75Ω. This output can be connected to the S-video input of a TV monitor via the proper cable.

In general S-video will result in a better quality picture due to limitations of the composite video luminance/chrominance circuitry used in TV monitors (producing dot crawl and limited luminance bandwidth). It is highly recommended that S-video be used whenever it is a feasible option.

Software

The software used for the AD724EB was developed for the AD720, but is still usable for the AD724. The software can be run from the floppy disk or can be installed on a hard drive. By running the INSTALL program, the software will be loaded into a directory called TV.

There is a TSR program called TV.EXE that changes the scanning of the graphics controller to interlaced format, 60 Hz (NTSC) or 50 Hz (PAL), and performs the appropriate vertical scaling to make the VGA format fit into a composite video frame.

To select NTSC scanning the command to use is TV -N [RETURN], and for PAL it is TV -P [RETURN]. The TSR can be unloaded by command TV -U [RETURN]. This TSR must be executed from DOS. It will not work when executed in a DOS window running under WINDOWS.

After the TSR is running, the hot-keystroke ALT-BACKSPACE will toggle the controller between non-interlaced (VGA) mode and interlaced (composite video) mode.

The DEMO file contains a collections of pictures for viewing image quality. Alternately, any other programs can be run to test the performance.

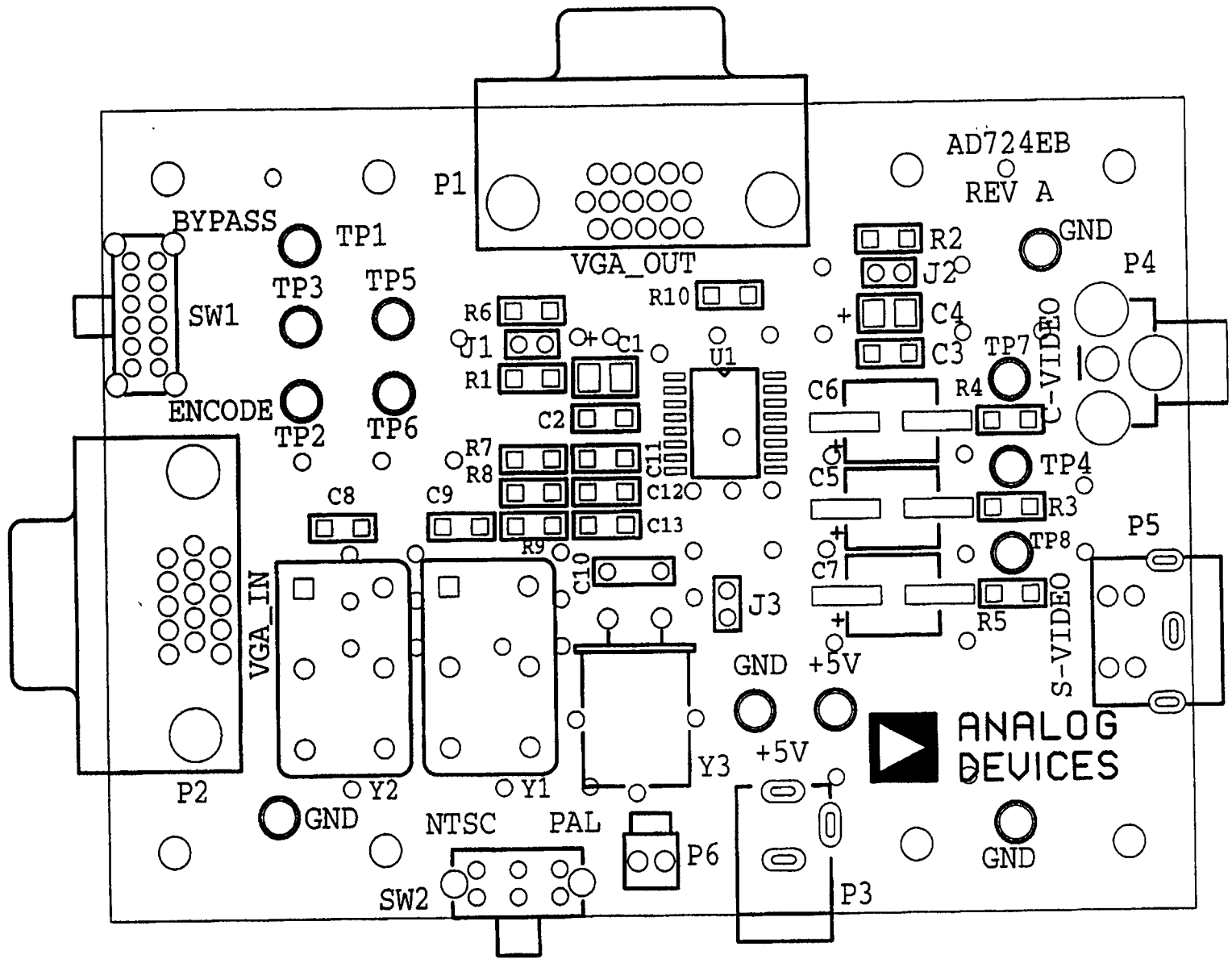

ASSEMBLY DRAWING

AD724 EVALUATION BOARD REV A

FEMALE VGA
VGA OUT

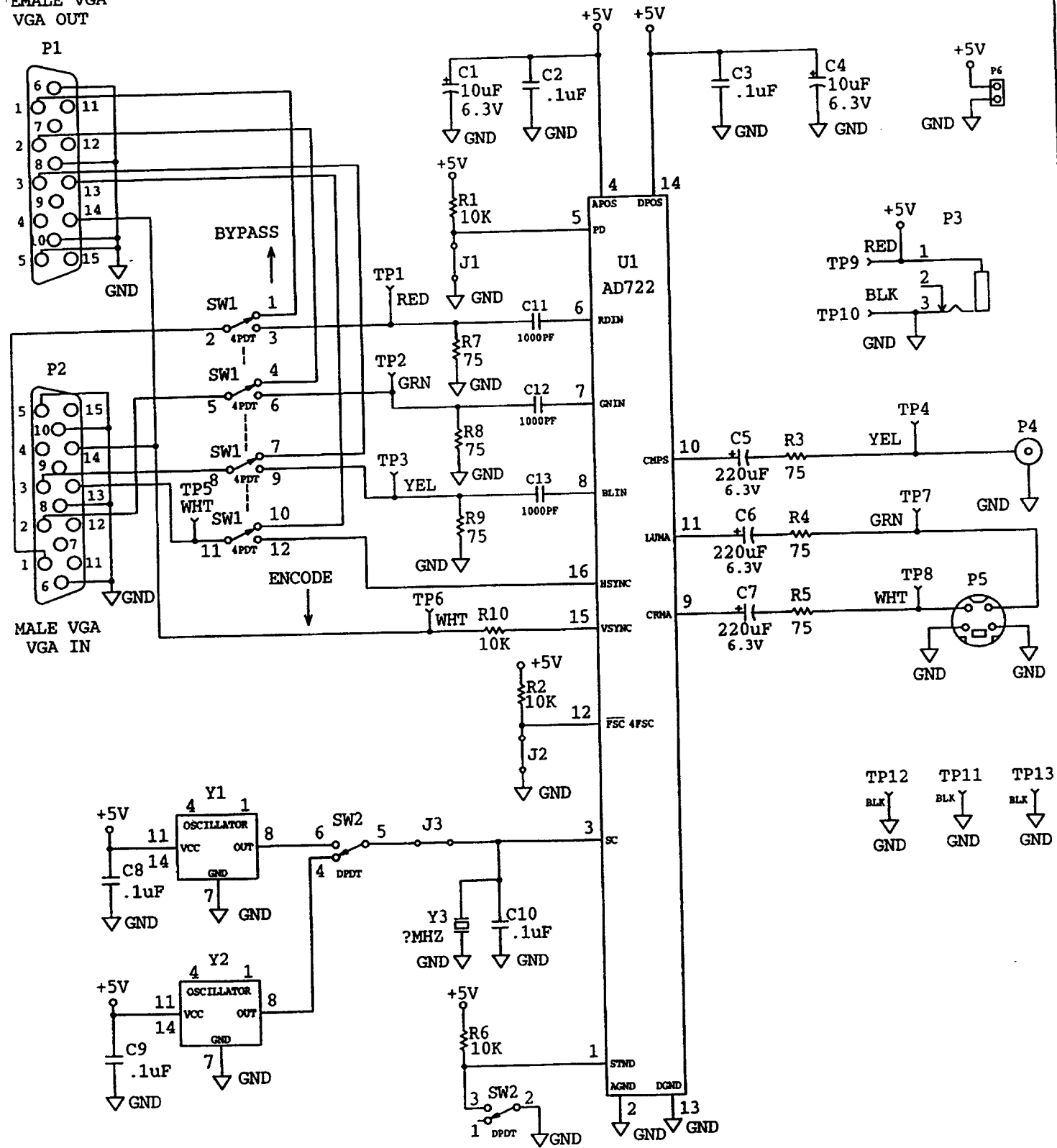

ANALOG DEVICES AD724 REV A

10 9 8 7 6 5 4 3 2 1

REVISIONS					
REV	ECO	DESCRIPTION	DWG	APPLS	DATE

SHEET
 AD724
 A

- NOTES:
- MATERIAL: .062 +/- .007 THICK FR4 GLASS-EPOXY LAMINATE, 1 OZ. COPPER CLAD BOTH SIDES.
 - PLATED THRU HOLES AND THE CONDUCTIVE PATTERN ELECTROPLATED WITH .001 INCH MIN. THICK COPPER. TERMINAL AREAS AND PLATED THRU HOLES TO BE COATED WITH 60/40 TIN LEAD AND HOT AIR LEVELLED. (SMOBC)
 - PROCESSING TOLERANCES:
 - CONDUCTIVE PATTERN FRONT TO BACK REGISTRATION WITHIN .005 INCH TOTAL.
 - MINIMUM ANNULAR RING SURROUNDING HOLES .005 INCH.
 - FINISHED CONDUCTIVE PATTERN WITHIN .002 INCH OF TRUE SIZE.
 - WARP AND TWIST WITHIN .010 INCH PER INCH.
 - DIMENSIONS: ARE FOR THE FINISHED PART.
 - SOLDER MASK: LIQUID PHOTO IMAGABLE SOLDER MASK OVER BARE COPPER COPPER (SMOBC), COLOR GREEN, BOTH SIDES USING THE PATTERN(S) PROVIDED. NO MASK PERMITTED ON THE TERMINAL AREAS. SOLDER MASK TO ETCH REGISTRATION WITHIN .005 INCH TOTAL.
 - SCREENING: SCREEN COMPONENT OUTLINES AND NOMENCLATURE USING INDELIBLE WHITE INK ON THE COMPONENT SIDE USING THE PATTERN PROVIDED. NOMENCLATURE SHALL BE LEGIBLE. SCREEN TO ETCH REGISTRATION WITHIN .020 INCH TOTAL.
 - SURFACES: PUNCHED OR MACHINED SURFACES 125 MICRO INCHES RMS MAX.
 - BREAK ALL SHARP EDGES .015 R MAX.
 - FABRICATION VENDOR TO ADD UL VENDOR NUMBER IN THIS AREA ON THE CIRCUIT SIDE.

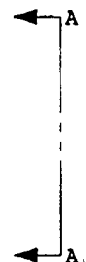
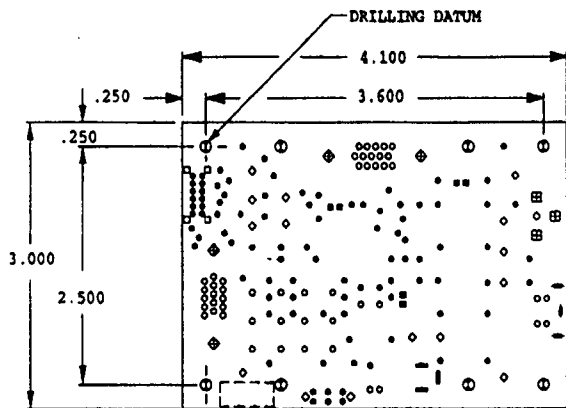

NOTE 11

HOLE LEGEND			
SYM	HOLE SIZE	COMMENTS	QTY
●	.032-.038 DIA.	AFTER PLATING	95
■	.035-.041 DIA.	AFTER PLATING	18
○	.043-.049 DIA.	AFTER PLATING	50
⊗	.052-.058 DIA.	AFTER PLATING	4
◇	.059-.065 DIA.	AFTER PLATING	16
□	.106-.112 DIA.	AFTER PLATING	3
⊕	.122-.128 DIA.	AFTER PLATING	4
≡	SLOT (.040 X .090)	AFTER PLATING	2
≡	SLOT (.040 X .090)	AFTER PLATING	1
≡	SLOT (.130 X .030)	AFTER PLATING	2
≡	SLOT (.130 X .030)	AFTER PLATING	1
①	.120-.130 DIA.	DO NOT PLATE	8

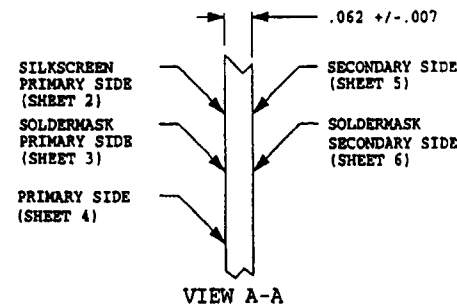

UNLESS OTHERWISE SPECIFIED DIMENSIONS ARE IN INCHES TOLERANCES		DRAWN DATE		ANALOG DEVICES		181 BALLARDVALE STREET WILMINGHAM, MASS. 01887	
DECIMALS ANGLES		DESIGN RESOURCES		FABRICATION		AD724 EVALUATION BOARD	
.X ± .XX ± .01 .XXX ± .005		CHECKED		ENGINEER		CODE IDENT. NO.	
MATERIAL		ENGINEERING MGR.		QUALITY CONTROL		SIZE	
FINISH		PRODUCTION		WEIGHT		REV.	
SEE NOTE 1		APPLICABLE SPECIFICATION		SCALE 1/1		AD724	
SEE NOTE 2		NEXT ASST		USED ON		SHEET 1 OF 6	
APPLICATIONS						A	

10 9 8 7 6 5 4 3 2 1

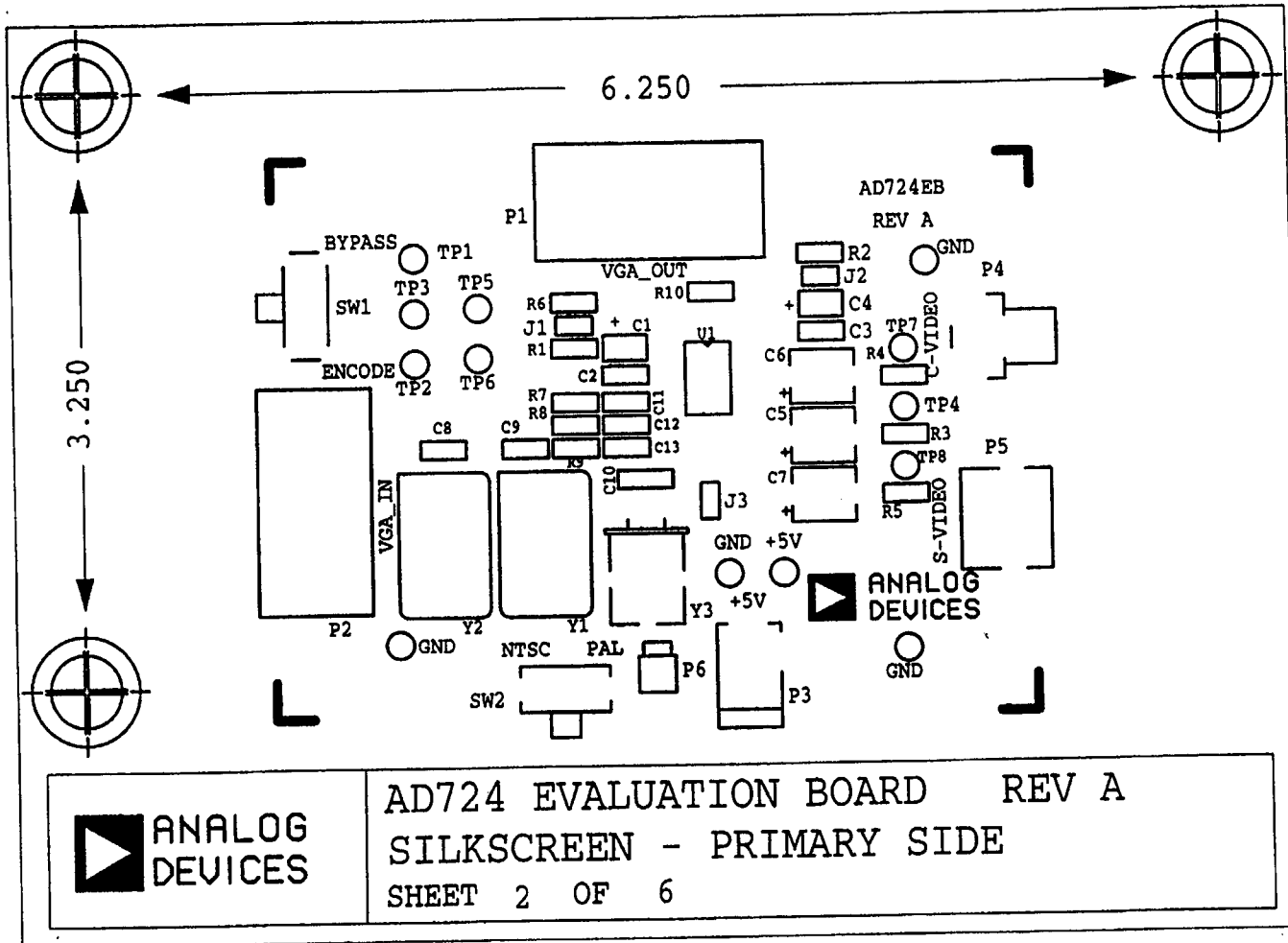

41K-20-1330 00.03 DESIGN SERVICES INC. 1 300 700 6370 1.1.1

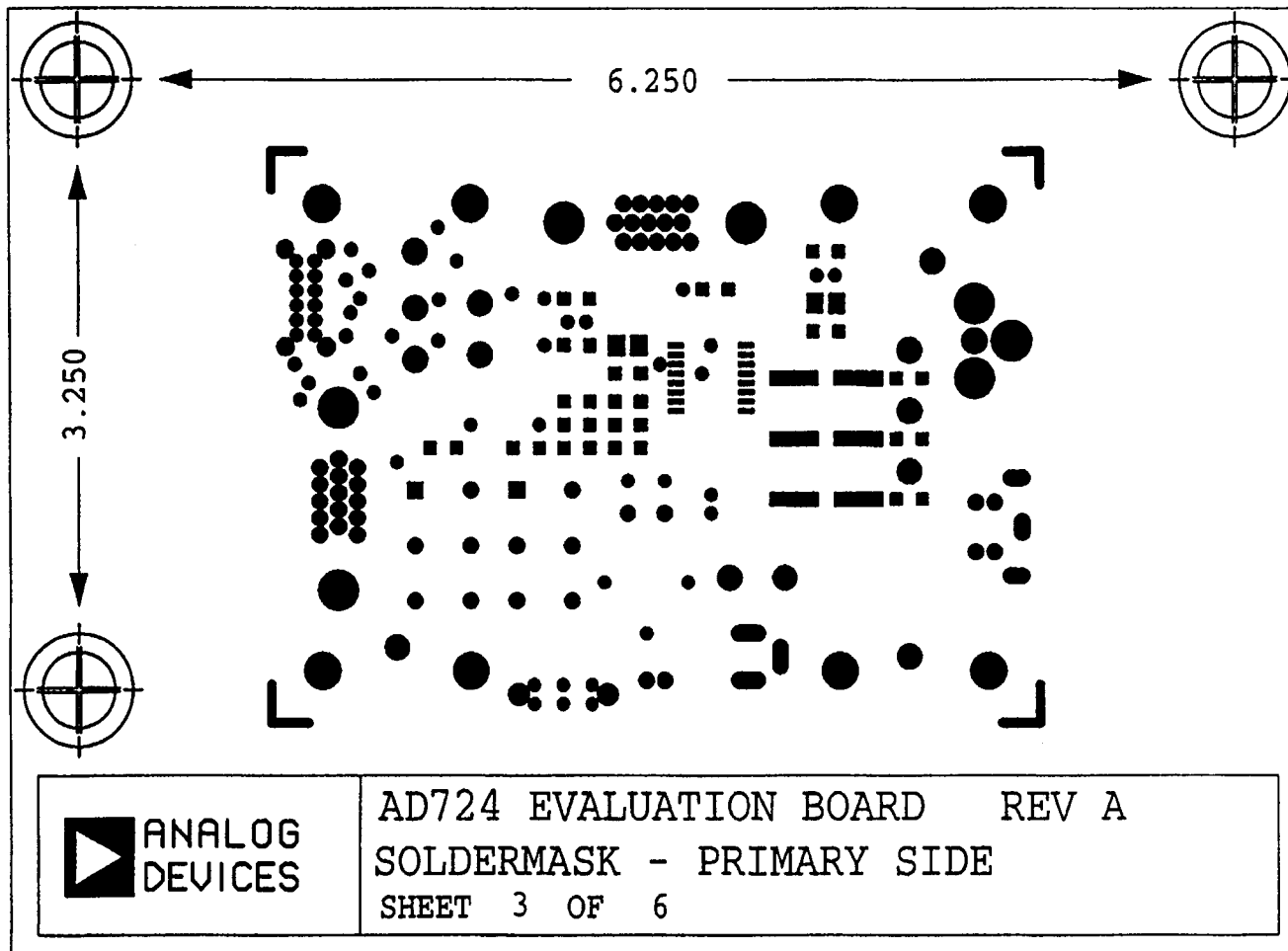

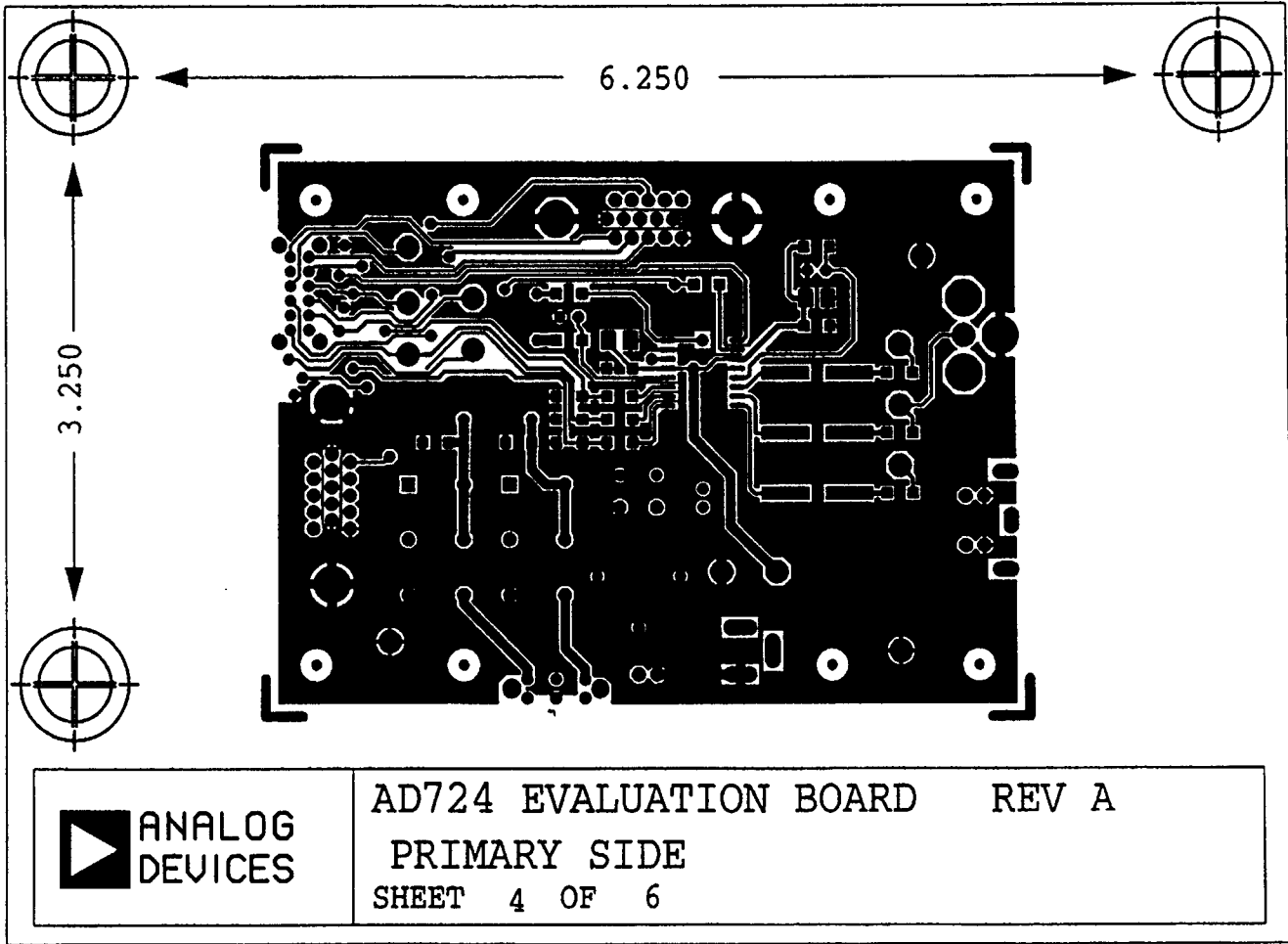

ANALOG DEVICES INC. 100 TOWERS DRIVE, BOSTON, MA 02115

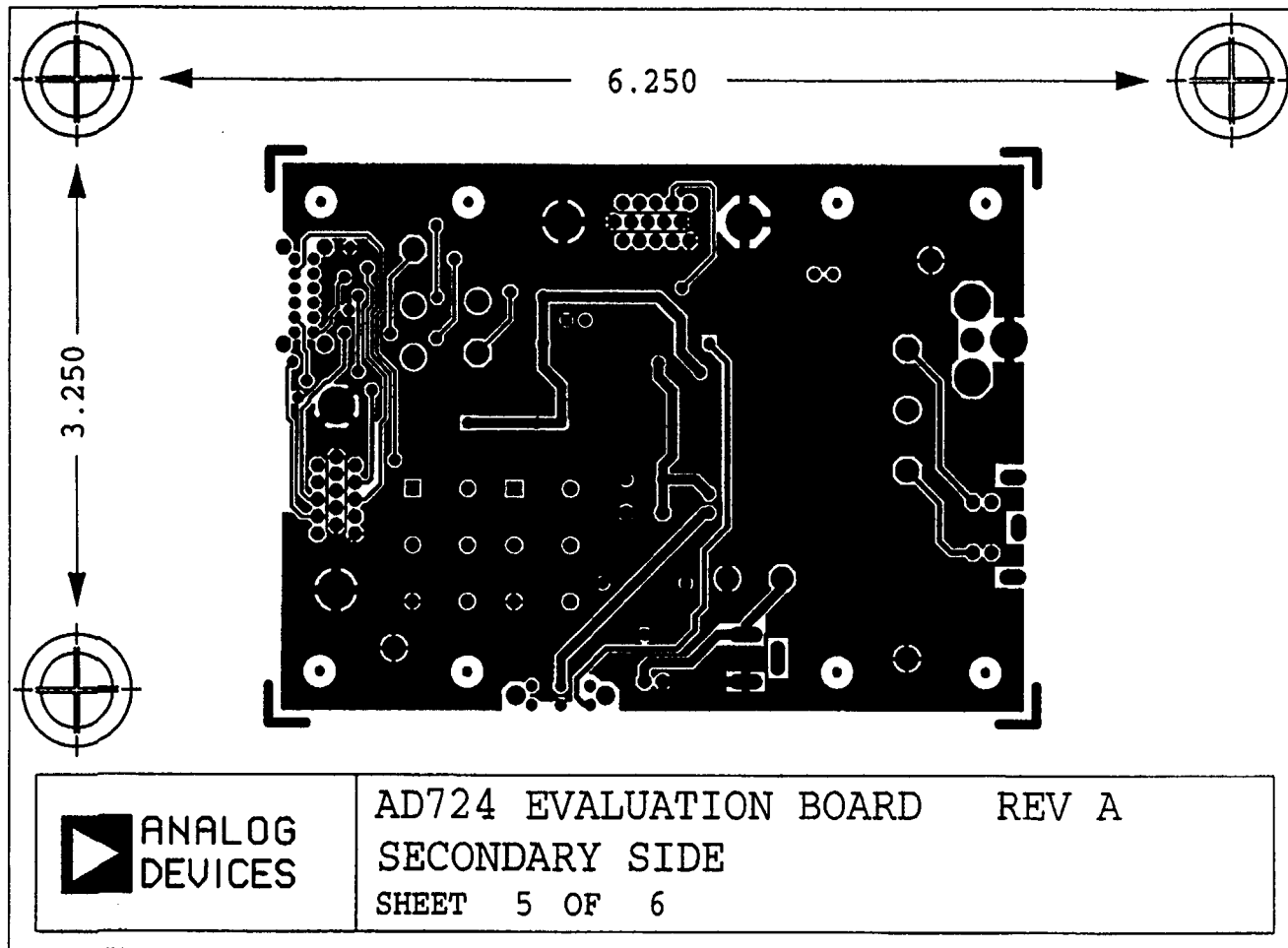

ANALOG
DEVICES

AD724 EVALUATION BOARD REV A
SECONDARY SIDE
SHEET 5 OF 6

